



Contract Pro

Product & Training Manual

Corded Backpack Vacuum Cleaner



pacvac.com

Product & Training Manual

Corded Backpack Vacuum Cleaners

Contents

| | |
|---|----|
| General Safety Instructions | 4 |
| Product Specific Safety Instructions..... | 5 |
| Specifications | 5 |
| Design Registrations..... | 5 |
| Symbol Definitions..... | 5 |
| Safety and Maintenance Checks | 6 |
| Safe Disposal | 6 |
| Wear Right | 7 |
| Troubleshooting | 8 |
| Service Requirements..... | 8 |
| Warranty..... | 9 |
| Spare Parts | 10 |
| Optional Extras..... | 11 |

CAUTION Read this Product & Training Manual before using the machine and instruct operators if applicable.
RETAIN FOR FUTURE REFERENCE.

This manual applies to the Contract Pro commercial backpack vacuum cleaner.

General Safety Instructions

WARNING To reduce the risk of fire, electric shock or injury, read all instructions before using. When using an electrical appliance, basic precautions should always be followed.

1. This Manual shall be considered an integral part of the machine and should be carefully looked after for subsequent reference.
2. **WARNING** Operators shall be adequately instructed on the use of this machine.
3. **WARNING** This machine is not suitable for picking up hazardous dust (Contact Pacvac for specific equipment for this use).
4. **WARNING** Do not use this machine in wet conditions.
5. **CAUTION** This machine is for indoor use only.
6. **CAUTION** This machine shall be stored indoors only.
7. The electrical specifications of this machine are displayed on the data plate which is located near the power switch. Ensure the specifications correspond to those of the mains power supply in your area. If the machine is without a data plate, contact the place of purchase immediately.
8. Do not restrict the vacuum cleaner's airflow. Maintain the vacuum cleaner regularly so that all filters and openings are free of dust, lint, hair build-up or anything else which may affect airflow. Refer to the maintenance instructions in the Product & Training Manual.
9. If the machine has been dropped, damaged, left outdoors or has been exposed to liquids, return it to your local authorised Pacvac Service and Warranty Agent for a safety check.
10. Do not use the machine to pick up flammable or combustible liquids, such as petrol etc. and do not use in areas where they may be present.
11. Do not vacuum anything that is burning or smoking such as cigarettes or hot ashes.
12. Do not vacuum up hard or sharp objects such as glass, nails, screws etc.
13. Keep hair, loose clothing, fingers and all parts of the body away from moving parts and openings.
14. Keep the machine and power cord away from heated surfaces.
15. Do not unplug the machine while it is turned on. Turn the machine off, turn the power off at the power outlet then unplug by grasping the plug and pulling gently to unplug.
16. Do not handle the machine, power cord or plug with wet hands.
17. Unplug from power point when not in use, before servicing or before changing filters and attachments.
18. Do not pull or carry the machine by the power cord.
19. Do not close doors on the power cord and do not pull the cord around sharp edges or corners.
20. Regularly check the power cord for damage, such as cuts, abrasions, exposed wiring or aging. If the power cord or plug is damaged, the complete power cord must be replaced by your local Authorised Pacvac Service and Warranty Agent in order to avoid an electric shock. The power cord should only be replaced with a Pacvac Genuine Spare Part with the same specifications.
21. Store in an appropriate place after use to prevent a trip hazard.
22. This appliance is not intended for use by persons (including children) with reduced physical, sensory or mental capabilities, or lack of experience and knowledge, unless they have been given supervision or instruction concerning use of the machine by a person responsible for their safety. Children should be supervised to ensure that they do not play with this machine.
23. Use only the manufacturer's recommended attachments and/or replacement parts.

Product Specific Safety Instructions

1. **WARNING** This machine is intended for the vacuuming of dry dust and/or small debris off dry carpeted or hard floor surfaces in indoor areas only.
2. **WARNING** Do not use the machine without the dust bag and filters in place.
3. The Contract Pro has an “A”-weighted emission sound \ pressure level of $66 \pm 3\text{dB(A)}$ (measured at 1.5 meters)
4. Floor Tool Part No. FLT002 - Multi-purpose floor tool 285mm is intended for vacuuming of dry dust and debris off floor surfaces.
5. Part No. ACC002 - Crevice tool 32mm is intended for vacuuming of dry dust and debris from crevices.

Motor Thermostat

IMPORTANT: The motor is equipped with a thermostat. If for any reason, the vacuum cleaner should over-heat, the thermostat will automatically turn the unit off. Should this occur, turn off the switch and unplug the vacuum cleaner from the electrical outlet and conduct safety and maintenance checks. Allow the cleaner to cool for approximately 30 minutes. To re-start, plug into a power point and switch back on.

RETAIN THESE SAFETY INSTRUCTIONS FOR FUTURE USE.

Specifications

| | |
|--|----------------------------------|
| Model Name | Contract Pro |
| Model No. | VB002TH01A |
| Volts/Frequency | 220-240V AC 50Hz |
| Motor | 1300W single-stage flow through |
| Noise Level (at 1.5m) | 66dB(A) |
| Filtration | 4 stage |
| Volumetric Airflow (Max.) | 55L/s |
| Capacity | 5L |
| Weight (excluding power cord assembly and hose) | 4.8kg |
| Power Source | Mains, 18m power cord, hardwired |
| Vibration Level | $\leq 2.5\text{m/s}^2$ |

Design Registrations

| | |
|----------------------|----------------|
| EP Registered Design | 001617051-0001 |
|----------------------|----------------|

Symbol Definitions

1. Attention!



2. Operator's Manual; Operating Instructions



*Technical specifications are subject to change without notice.

Safety and Maintenance Checks

DAILY

1. Replace the disposable sealed SMS dust bag if needed. Remove, empty and clean the reusable dust bag.



2. Remove the filter and tap gently to clean.

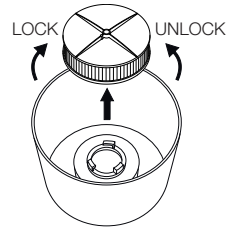

3. Check all power cords and ensure there are no cuts, abrasions or exposed wiring.

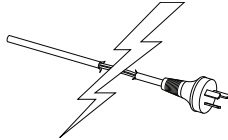

4. Check the floor tool, wand, handpiece and hose for any obstructions.

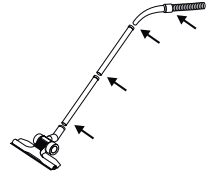

5. Wrap loosely the cable from the backpack towards the plug. Store power cord on the 'hook' on the frame.

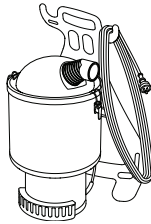

WEEKLY

- Remove and clean the external motor filter.

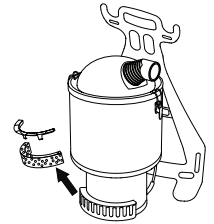

NOTE: Any other servicing should be performed by an Authorised Service & Warranty Agent. Please do not use if any damage is found.

Safe Disposal

Contact your local waste authority for information regarding available recycling and/or disposal options. Or contact Pacvac by emailing support@pacvac.com or phone +61 8 9479 1444 for the latest information.

Wear Right

In preparation of wearing the machine, follow these simple principles:

1



Wear comfortably

Loosen the shoulder straps and adjust the length, if required.

Lift the backpack by one shoulder strap and slide your free arm into the other strap.

2

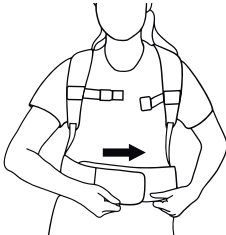

Tighten harness hipband

Wrap the attached harness hipband around your hips and adjust to ensure a comfortable fit.

3

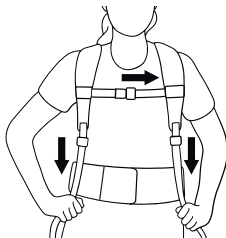

Adjust straps

Pull down on the shoulder straps until it feels comfortable.

Adjust the chest strap to the correct position for you, and click together to secure.

4

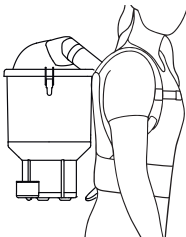

Correct posture

Make sure the machine is fitted comfortably to your frame.

IMPORTANT

If the backpack feels heavy or uncomfortable, it is likely you are not wearing it correctly. Contact Pacvac for further advice.

Troubleshooting

Caution: Always unplug the backpack before attempting to solve a problem or when servicing.

| Problem | Cause | Solution |
|-------------------------------|---|--|
| Backpack not working | Power cord not firmly plugged into power point. | Check all plugs and sockets are firmly plugged in. |
| | Backpack shuts off due to high motor temperature. | Turn main switch off and unplug the backpack. Conduct safety and maintenance checks found in this Product and Training Manual or as per labelling on the machine. After 30 minutes (60 minutes for wispa) the backpack should be ready for use. If not contact the number below for your nearest Authorised Pacvac Service and Warranty Agent. |
| | Circuit breaker or RCD has tripped. | Check the machine is in good working order. If OK, reset circuit breaker or RCD. If circuit breaker or RCD trips again contact your nearest Authorised Pacvac Service and Warranty Agent. |
| Backpack has no/poor suction. | Dust bag is full. | Remove, empty and clean dust bag. |
| | Dust bag not installed | Remove and re-insert making sure the rubber edging is correctly fitted around the canister. For disposable dust bag ensure it is firmly sealed around inlet. |
| | Hose not installed correctly. | Reconnect hose and ensure correctly sealed. |
| | Blockages. | Remove hose, wand and floor tools; remove any blockages. |
| | Filters blocked. | Replace filter and tap gently to clean. |

Service Requirements

Our products are designed and built to be functional and durable. For information on use and maintenance please read this Product & Training Manual thoroughly.

Should you require servicing contact your nearest Authorised Pacvac Service and Warranty Agent.

Warranty

Your Pacvac Pty Ltd (Pacvac) product has been manufactured to meet our highest quality standards. We urge you to take good care of your product and be sure to follow instructions carefully. This will provide you with the best possible performance and lifespan of the product.

The inclusion of the following paragraph is a requirement by Australian Law. It explains that consumers have rights by law regardless of any warranties provided or not by a manufacturer or supplier.

“Our goods come with guarantees that cannot be excluded under the Australian Consumer Law. You are entitled to a replacement or refund for a major failure and for compensation for any other reasonably foreseeable loss or damage. You are also entitled to have the goods repaired or replaced if the goods fail to be of acceptable quality and the failure does not amount to a major failure.”

In addition to the guarantees under Australian Consumer Law, Pacvac warrants all machines and their components against faulty material and / or workmanship for a period of two years from the date of purchase by the original consumer.

The following explains conditions and what to do in the event of a claim:

Pacvac will replace parts determined as faulty however this does not cover reasonable wear through normal use of any consumable parts, such as but not limited to, bags, filters, hoses, electrical leads, carbon brushes and floor tools etc.

Warranty does not cover any machine or component that has been altered, abused, neglected, modified, used with non-genuine Pacvac components or has not been used and maintained as indicated in this Product & Training Manual.

Warranty repairs can only be carried out by an Authorised Pacvac Distributor or Repairer. Visit our website for your nearest location. Warranty claims are limited to the original warranty period from the date of purchase. Warranty repairs and / or replacements do not extend the original warranty period.

All reasonable expenses associated with returning goods for a warranty claim are the consumer's responsibility.

Claims must be made within two years of the date of purchase and proof of purchase must be supplied with the claim.

To make a claim under warranty, take the product with proof of purchase to the place of purchase. If the place of purchase does not satisfactorily rectify the matter, please contact Pacvac.

Pacvac has the right to request pictures of warranty product failures or to request for those parts be returned to Pacvac's office in Western Australia.

The replacement of any part shall be at Pacvac's discretion.

 +61 8 9479 1444  support@pacvac.com  pacvac.com

Spare Parts

Quote these part numbers when ordering spare parts for all models.

| No. | Part Name | Part No. |
|-----|--|----------|
| 1. | Crevice tool 32mm | ACC002 |
| 2. | Front motor filter cage (green) | CAG010 |
| 3. | Cord restraint | COR004 |
| 4. | 5L SMS Bags Disposable (10pk) | DUB036 |
| 5. | Reusable SMS dust bag 5L (green) | DUB023 |
| 6. | Pre-motor cartridge filter 68mm (grey) | FIL002 |
| 7. | Exhaust foam filter | FIL004 |
| 8. | Multi-purpose floor tool 285mm | FLT002 |
| 9. | Harness back and hip band | HAR001 |
| 10. | Screw fit hose 1.2m (curved handpiece - green) | HOA017 |
| 11. | Clear lid 5L | LID001 |
| 12. | Padded shoulder strap | STP003 |
| 13. | Plastic two piece wand | WND003 |

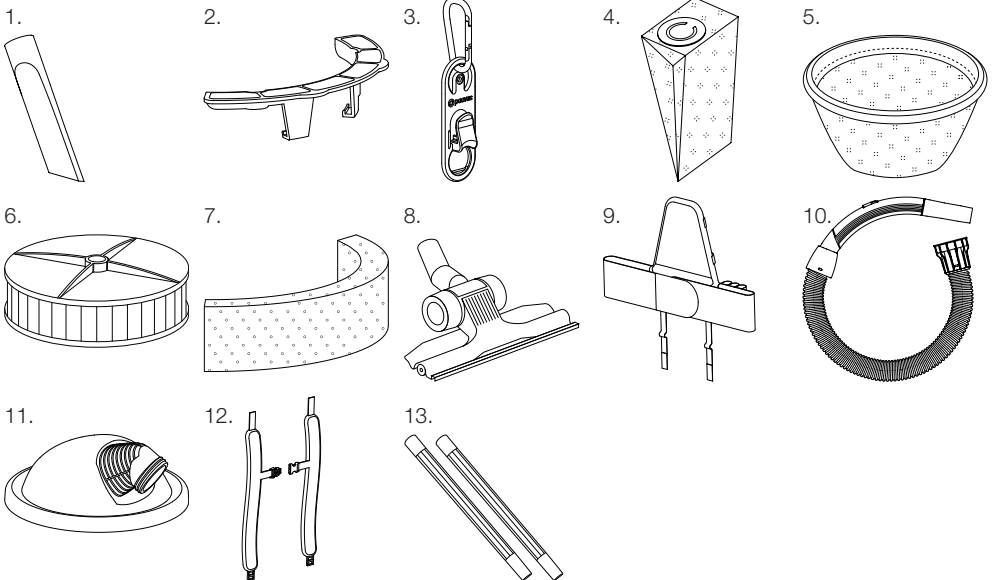

*Technical specifications, part numbers and parts designs are subject to change without notice.

Optional Extras

Quote the following part numbers when ordering spare parts for all models.

| No. | Part Name | Part No. |
|-----|-------------------------------|----------|
| 14. | 20m extension cord | EXL002 |
| 15. | Combination floor tool 270mm | FLT003 |
| 16. | Hard surface floor tool 300mm | FLT005 |
| 17. | Turbo head floor tool 280mm | FLT007 |
| 18. | Dual mode floor tool 270mm | FLT012 |
| 19. | Chrome extendable wand 950mm | WND001 |
| 20. | Chrome two piece wand | WND002 |

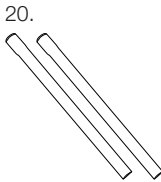
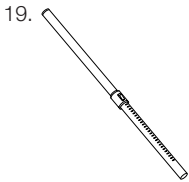
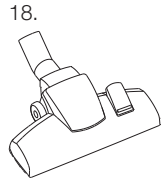
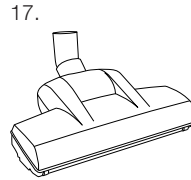
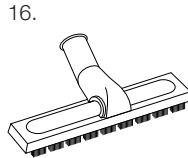
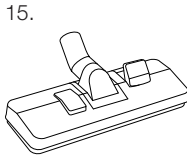
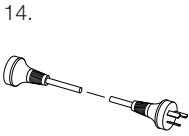

Online Manual

Visit rapidclean.com.au or scan the QR code to access the online manual.



Revised: November 2023
MAN028-220901-contract-pro-manual

Pacvac Pty Ltd
ABN: 60 709 396 593
7 Mackay Street, Kewdale WA 6105
AUSTRALIA

 +61 8 9479 1444  support@pacvac.com  pacvac.com